



## OWNER'S MANUAL

### PIZZA PREPARATION TABLES

Model:  
APP44  
APP67  
APP93



**Please read the manual carefully and follow all instructions.  
Failure to do so may void your warranty.**

# TABLE OF CONTENTS

▪ Transportation	3
▪ Installation and Set Up	3
▪ Connecting to a Power Supply	4
▪ Operating instructions	4
▪ Control Panel/Digital Display	5
▪ Maintenance and Cleaning	7
▪ Troubleshooting Guide	7
▪ Proper Disposal	8
▪ Circuit Diagram	9
▪ Technical Parameters	10
▪ Approvals	10

**The manufacturer cannot be held liable in the following cases:**

- Improper installation and servicing
- Misuse of the refrigerator
- Improper or inadequate maintenance
- Unauthorized modification or tampering
- Use of non-original spare parts
- Partial or total failure to comply with the instructions

**TRANSPORTATION**

Unit may not be shipped and placed on its side. It should be stored in a protected and covered environment at a temperature between -13 and 131 degrees Fahrenheit with an ambient humidity of 30 to 90%. Do not stack more than 4 units high.

**INSTALLATION and SET UP**

**UNIT MUST RUN FOR 24 HOURS BEFORE USING!**

-The unit is wrapped in absorbent material inside a cardboard box and strapped on a wood pallet. Remove all straps and packaging, including the PVC protective film. If damage is noted, file a claim right away.

-Install the units on a level surface. If the surface is not level, the legs can be adjusted.

-Make sure that it is not placed in direct sunlight or by a heat source.

-There should be 5cm clearance from wall and unit so that there is proper air circulation for the condensing unit.

-Before use, the interior and exterior should be cleaned with a soft cloth.

Do not use an abrasive cleaner or scour pad!

## CONNECTING TO THE MAIN POWER SUPPLY

- Before plugging in, make sure that the main power source is grounded properly and matches the voltage rating of that of the unit (found on the rating label).
- Do not in any way remove the ground prong.
- Always make sure that the power cord is in good condition, is not frayed and does not show abrasion.
- Do not use an extension cords or adapter plugs and only plug in one unit per circuit.
- When plugging and unplugging, do so by gripping onto the plug.
- Plug in the unit and adjust the thermostat to your desired temperature.

## OPERATING INSTRUCTIONS

After connecting the power supply, press the “POWER” switch on the keyboard (Green Indicator Light ON). The digital control automatically adjusts the temperature ranges; if the temperature increases and reaches the set point plus differential, the compressor starts and turns off when the temperature reaches the set point value again.





## DIGITAL CONTROL

**SET** To display target set point. In programming mode, it selects a parameter or confirms an operation





(Mod. XR06CX)

 To start a manual defrost



 In programming mode, it browses the parameter codes or increases the displayed value

 In programming mode, it browses the parameter codes or decreases the displayed value

 +  To lock or unlock the keyboard

**SET** +  To enter in programming mode

**SET** +  To return to room temperature display

LED	MODE	SIGNAL
	On	Compressor enabled
	Flashing	Anti short cycle delay enabled(AC)
	On	Defrost in progress
	Flashing	Dripping in progress
	On	Fans output enabled
	Flashing	Fans delay after defrost
°C	On	Measurement unit
	Flashing	Programming mode
°F	On	Measurement unit
	Flashing	Programming mode



### 1. How to View the Set Point

Push and immediately release the SET key, the set point will appear.

Push and immediately release the SET key or wait about 5s to return to previous screen .

### 2. How to Change the Setpoint

Push the SET key for more than 2 seconds to change the Set point value.

The value of the set point will be displayed and the “°C” or “°F” LED starts blinking. To change the Set value push the  or  arrows.

To set the new point value, push the SET key again or wait 10s.



### 3. How to Start a Manual Defrost

Push the DEF  key for more than 2 seconds and a manual defrost will start.

### 4. How to Change a Parameter Value

Enter the Programming mode by pressing the SET+ keys for 3s (“°C” or “°F” LED starts blinking).

Select the required parameter. Press the “SET” key to display its value.

Use  or <sub>AUX</sub> to change its value.

Press “SET” to store the new value and move to the following parameter.

To exit, press SET+ or wait 15s without pressing a key.

NOTE: the set value is stored even when the procedure is exited by waiting for the time-out to expire.

### 5. To Lock Keyboard

Press the + keys for more than 3s.

The “OF” message will be displayed and the keyboard will lock.

### 6. To Unlock the Keyboard

Press the + keys until the “on” message is displayed.

### 7. Alarms

Mess.	Cause	Output
“P1”	Room probe failure	Compressor output according to “Cy” e
“P2”	Evaporator probe failure	Defrost end is timed
“HA”	Maximum temperature	Outputs unchanged
“LA”	Minimum temperature	Outputs unchanged
“EA”	External alarm	Outputs unchanged
“CA”	Serious external alarm	All outputs OFF
“dA”	Door Open	Compressor and fans restarts

## **MAINTENANCE AND CLEANING**

Regular cleaning of the unit is strongly recommended each month.

-Before cleaning, power off and unplug the unit.

-Clean the exterior and interior with a mild detergent and soft cloth. Do not use abrasive detergents and cloths!

### **Cleaning the Condenser**

The condenser should be thoroughly cleaned every 4 months or when the fins get dirty. It can be cleaned with a dry brush or a vacuum cleaner.

## **TROUBLESHOOTING**

**Unnecessary service will be billed to the customer. Please make sure to go over this troubleshooting guide before calling for service.**

### **Power supply failure**

- Check that the plug is plugged in correctly
- Make sure that the switch is on
- Check the main power source

### **Required temperature is not achieved**

- Check that the thermostat range is correctly regulated
- Check that the condenser is not blocked with dust. Improper air flow will affect unit to function at its optimal level
- Unit should not be over-stuffed, and not loaded with hot food
- Make sure that the unit is not close to a heat source

### **Cabinet is leaking water**

- The drip tray may be missing or damaged
- Make sure the pipes are not obstructed
- The unit may not be level

Cabinet is noisy

- The unit may not be level
- The frame may have loose screws or bolts

If problems persist after following the troubleshooting guide, please contact your local dealer and have ready your model number, serial number, and date of purchase. You may be asked to also provide proof of sales.

## **PROPER DISPOSAL**

Proper disposal is the responsibility of the owner, and these instructions should be followed to prevent injuries and child entrapment.

- Remove all doors and shelves so that a child cannot get trapped inside.
- Follow the guidelines of the city garbage disposal program
- The refrigerant will need to be removed by a qualified service technician.



# CIRCUIT DIAGRAM

Temperature range (+33°F~+45°F)

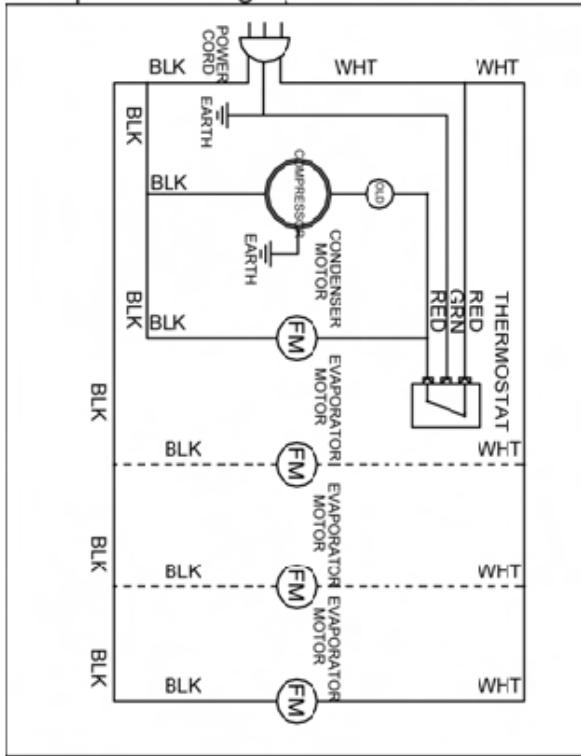

Temperature range (-8°F~-1°F)

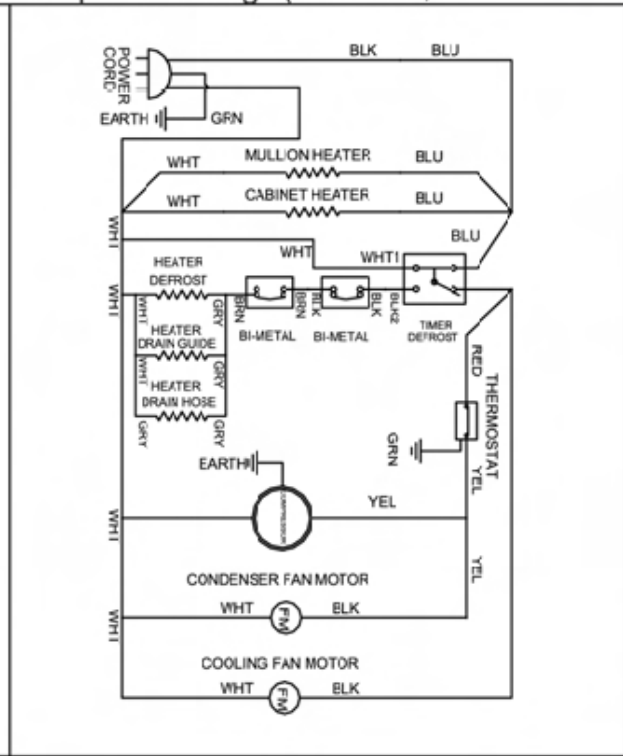

## TECHNICAL PARAMETERS

Model	Description	Power Source(V)	Rating frequency(Hz)	Input power(W)	Temperature Range(F)	Refrigerant	Dimension(inches)	Net Weight(lb.)
APP44	Pizza Prep Table - 1 Door	115	60	280	33~45	R134a	44*33.50*41	309
APP67	Pizza Prep Table - 2 Door	115	60	410	33~45	R134a	67*33.50*41	550
APP93	Pizza Prep Table - 3 Door	115	60	500	33~45	R134a	93*33.50*41	697



**Intertek**  
4003935  
CONFORMS TO UL STD.471  
CERTIFIED TO CSA STD.C22.2 NO.120



**Intertek**  
4003935  
CONFORMS TO NSF/ANSI STD.7

**Aurora Customer Service Line:**

**701-864-2866**